

APTUS® *a fitting solution*

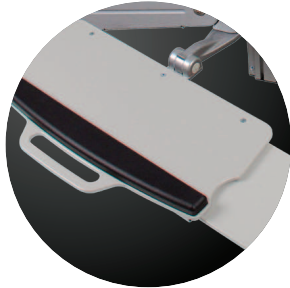

Intelligently Designed

- Single-hand workstation adjustments are effortless, optimizing workflow efficiencies while sitting or standing
- Superior overall height adjustment range compared to other workstations maximizes versatility, ergonomics and comfort
- OSHPD Approved and Engineer Certified ensures installations meet local building codes and infrastructure requirements

Installs In Minutes

- Ships pre-assembled, resulting in minimal after-sale installation costs and reduced “down time” for critical care areas
- Complete mounting hardware is supplied, resulting in seamless integration into multiple mounting surfaces
- Direct to drywall applications optimize positioning in rooms with limited real estate

Built for Life

- Maximum durability leads to long-term dependability within varying EMR implementations and adaptations
 - Superior weight capacity compared to other workstations, leading to the most adaptable solution for evolving technology
 - Optional Pivot Limiter prevents over-rotation of arm into unwanted spaces, protecting surrounding areas from damage
-

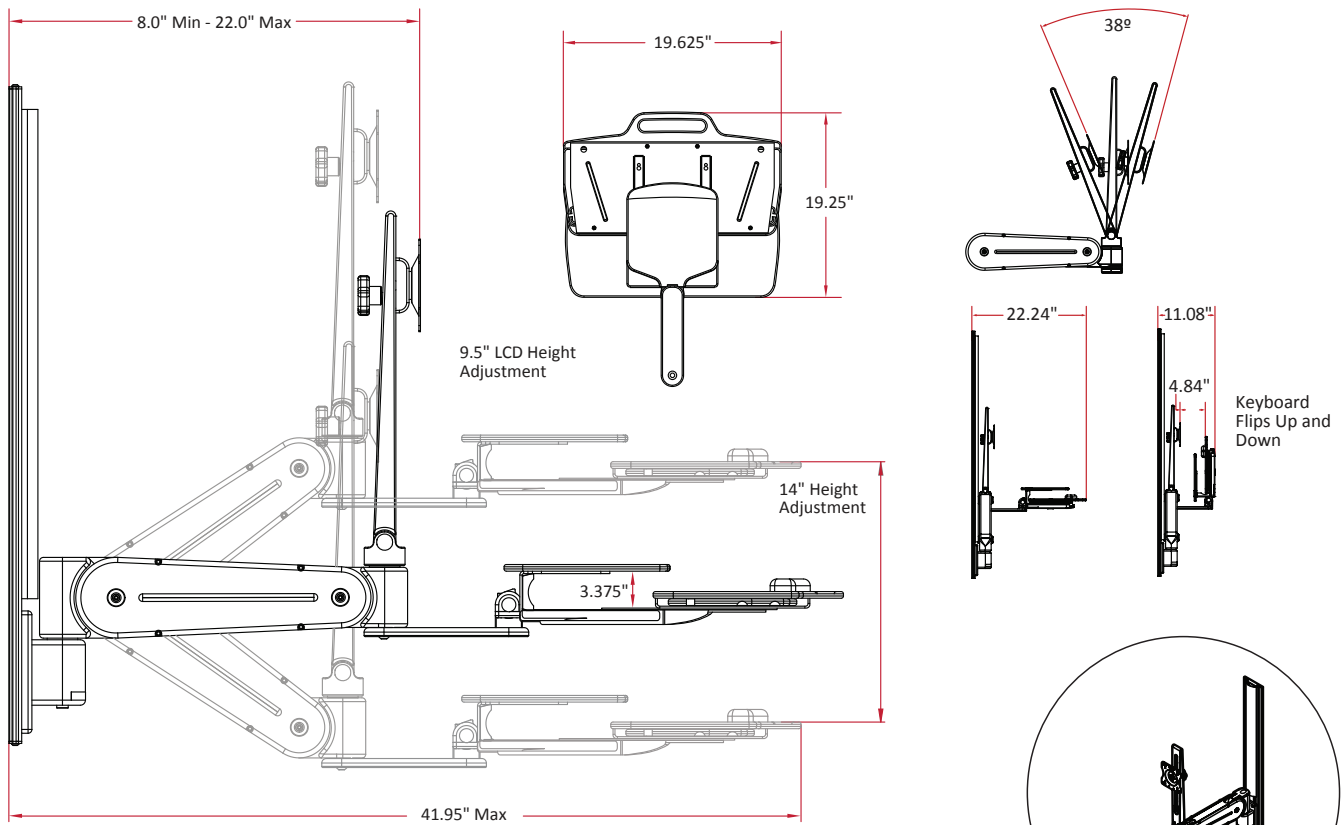

**APTUS®
Accessories**

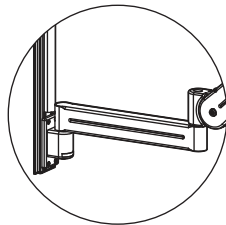

18" Extension Arm
518-2327

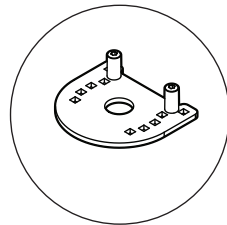

Pivot Limiter
518-2329

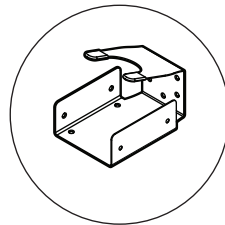

Scanner Holder
518-2332/518-2333

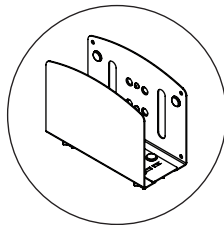

CPU Cradle
518-2330

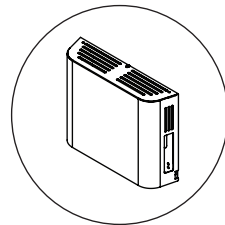

CPU Cabinet
518-2331

Each system can be attached to an MSC headwall or the building wall.

IMPORTANT: If attached to headwall, APTUS® system must be attached to a back-braced monitor channel within MSC Headwall, Column or Service Module, or MSC horizontal monitor channel assembly (518-2301 or 518-2302). If attached to building wall, the wall must be reinforced with bracing to support the APTUS® system.

APTUS® HD Workstation

| Model | Description | LCD Height Adjustment | Combo Arm Max Weight | Combo Arm Reach | LCD Rotation | Counterbalanced Height Range | LCD Tilt Range | Finish | Mounting Standard |
|----------|--|-----------------------|----------------------|-----------------|--------------|------------------------------|----------------|--------|-------------------|
| 518-2320 | APTUS® HD Workstation (channel not included) | 9.5" | 10-36 lbs. | 8" - 40" | 360° | 270° | 38° | Silver | VESA 75mm/100mm |

Shipping weight: 45 lbs. Box dimensions: 36 1/4" x 21" x 8 7/8"

